

① = start

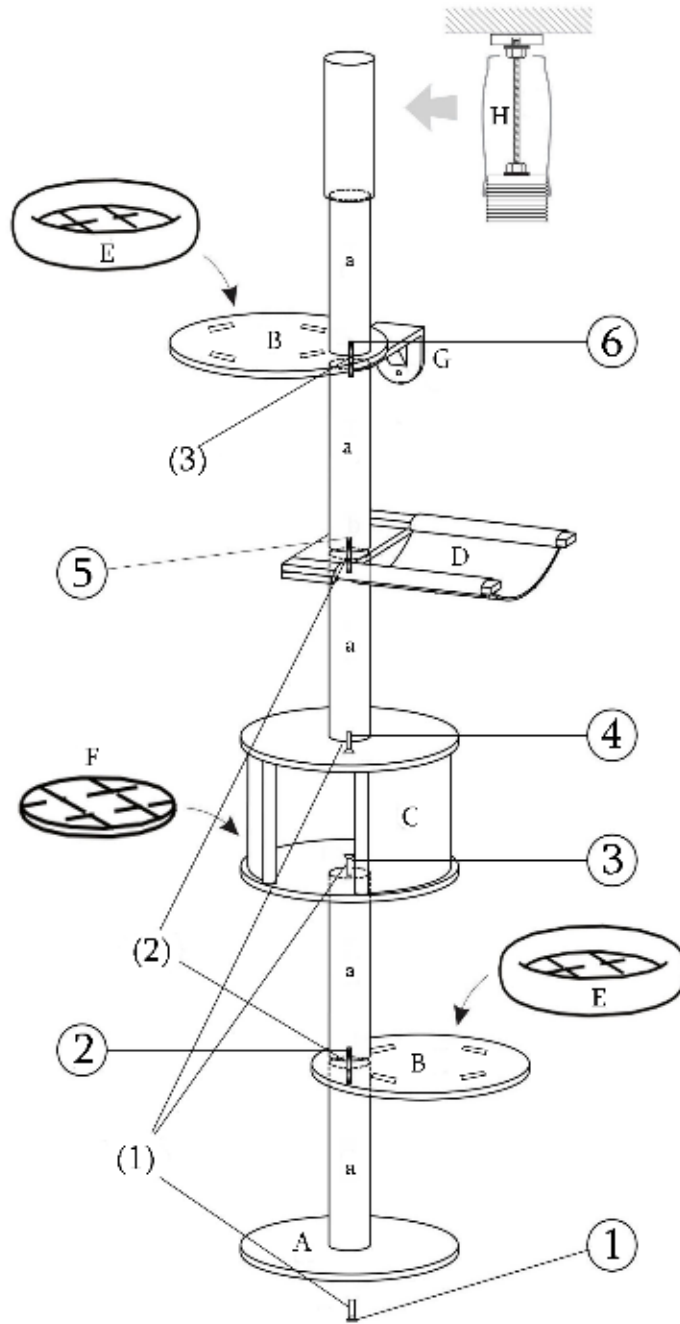

Potrzeba jednej śruby, aby z użyciem elementu "G" przymocować drapak do ściany. Śróbka nie jest załączona w komplecie.



1X  A

2X  B

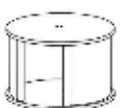
1X  C

1X  D

2X  E

1X  F

1X  G

3X  M8*40 mm (1)

2X  M8*90 mm (2)

1X  M8*90 mm (3)

1X  H

5X  a(40cm)

1X 

LA 67252
LA 69672

Made in Georgia